

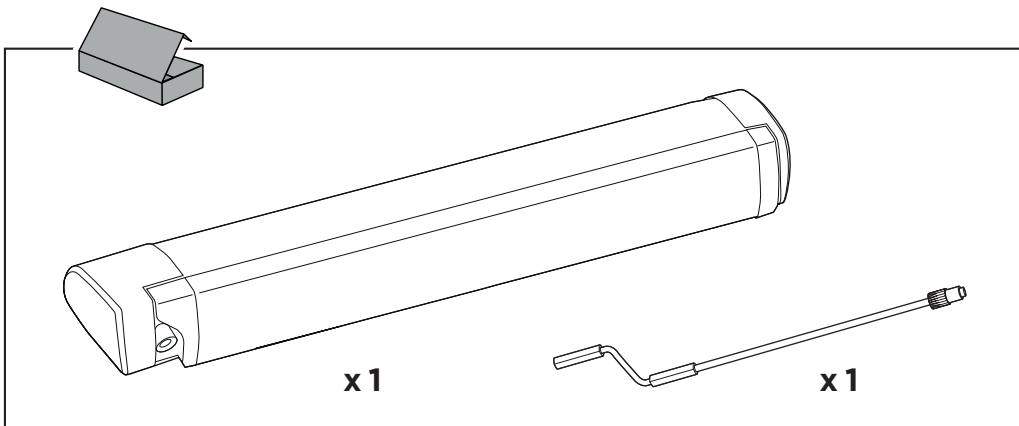

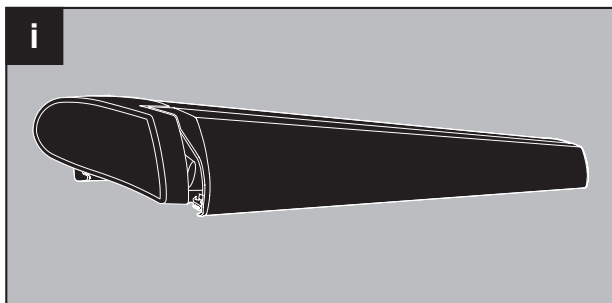

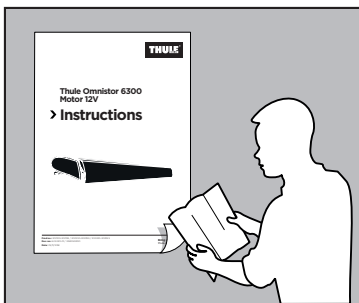

Thule Omnistor 6300 Motor 12V

➤ Instructions



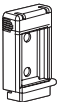

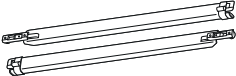
 Kg	25.1 kg	26.1 kg	27.8 kg	29.5 kg	31.5 kg	32.8 kg	34.0 kg	36.6 kg
	3.03 m	3.28 m	3.53 m	3.78 m	4.03 m	4.28 m	4.53 m	5.03 m
	x 2	x 2	x 2	x 2	x 2	x 2	x 2	x 2
	x 2	x 2	x 2	x 2	x 2	x 2	x 2	x 2
	x 2	x 2	x 2	x 2	x 2	x 2	x 2	x 2
Tension Arm Set TO 6300 302095								
	OPTION	OPTION	OPTION	✓	✓	✓	✓	✓

i

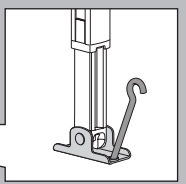
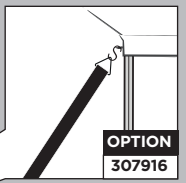
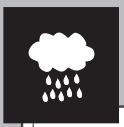
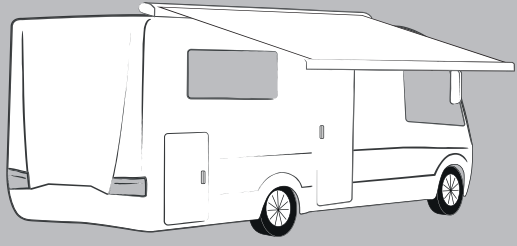
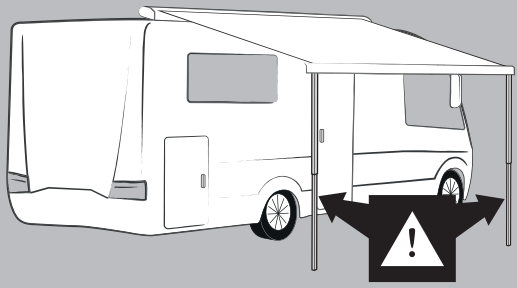
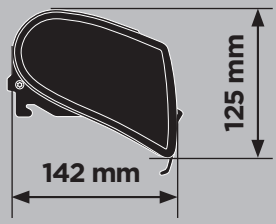
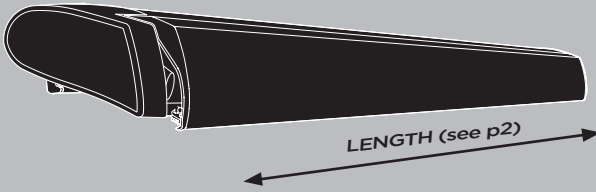



i

One Touch System

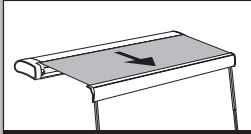

OPEN

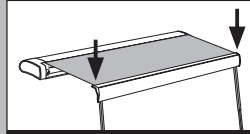
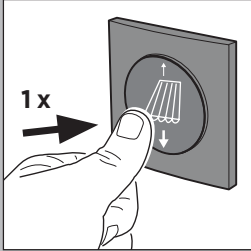

STOP

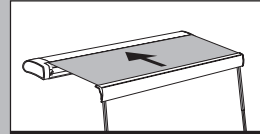
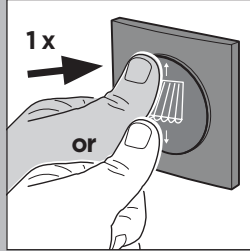

CLOSE

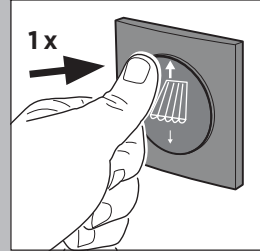

1

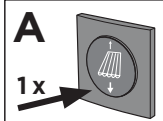
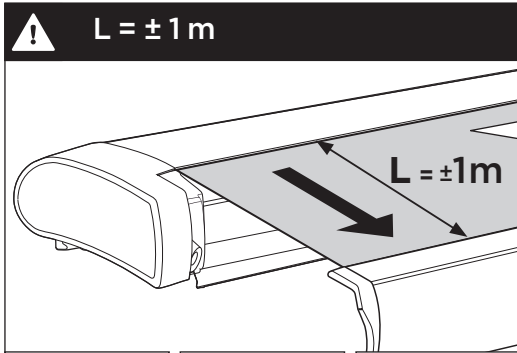

OPEN

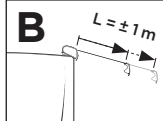

$L = \pm 1\text{ m}$

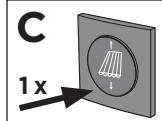

STOP

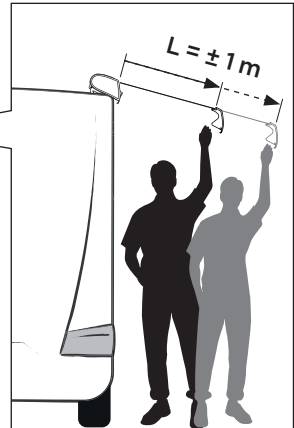

2

A

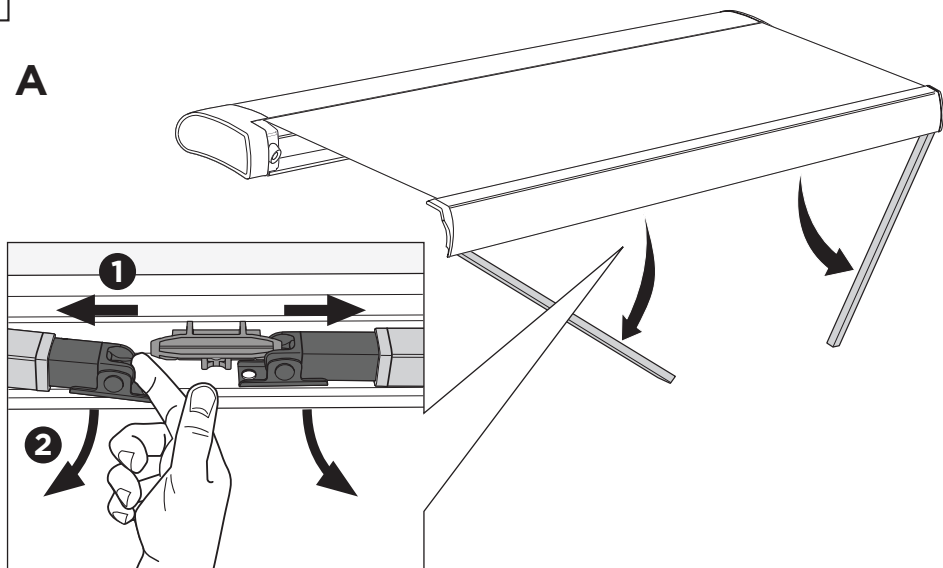

B

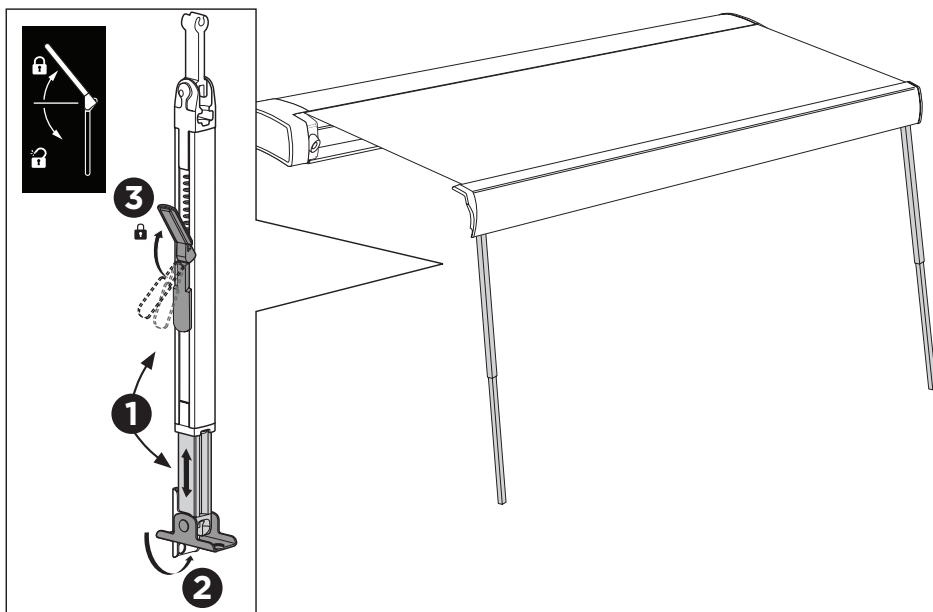

3

A

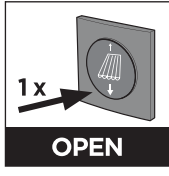

B

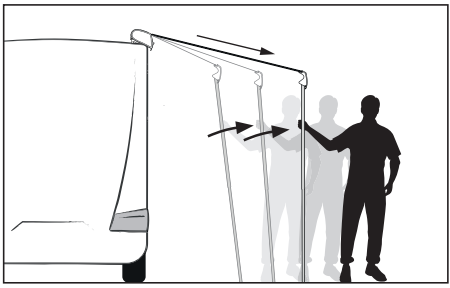

C

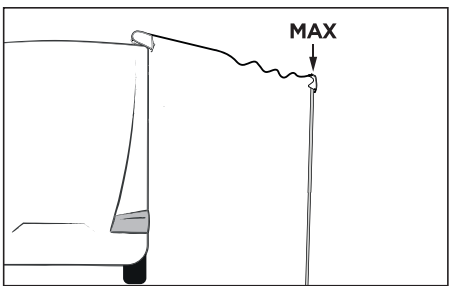

D

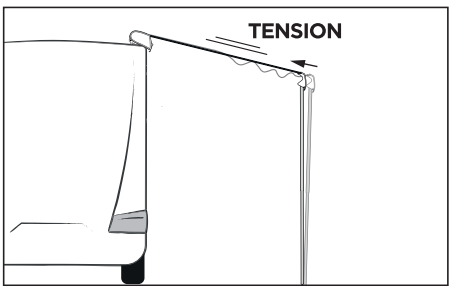

AUTOMATIC



4



EXTRA TENSION

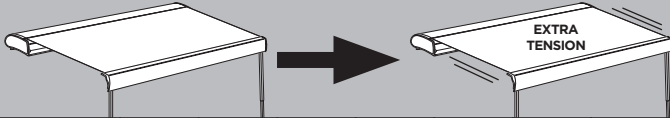

Tension Arm Set TO 6300 302095	3.03 m	3.28 m	3.53 m	3.78 m	4.03 m	4.28 m	4.53 m	5.03 m
	OPTION	OPTION	OPTION	✓	✓	✓	✓	✓

2 x

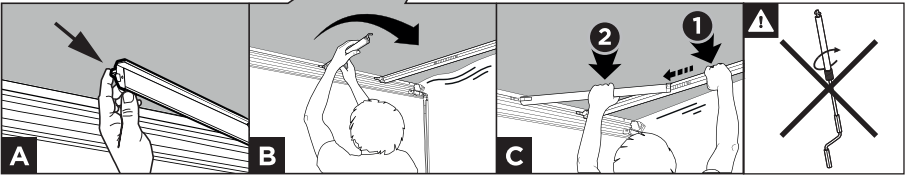
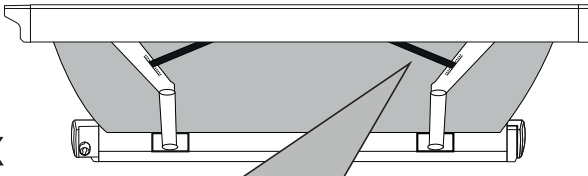

5

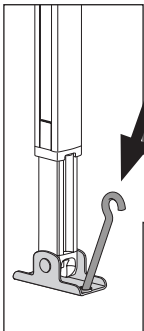

2 x

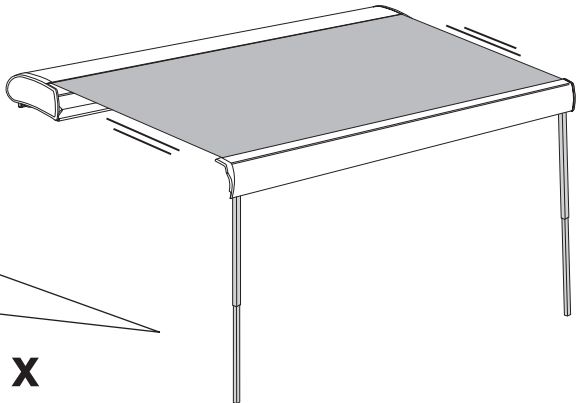



i

One Touch System

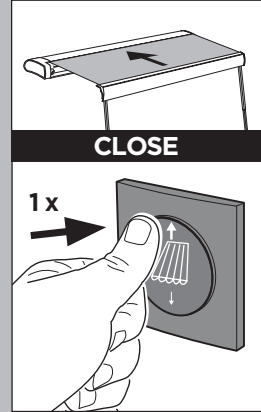
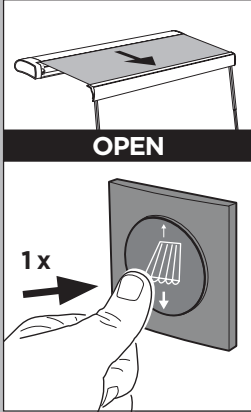

1

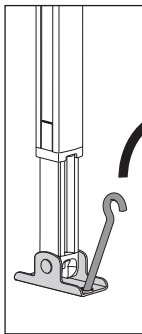

2 x

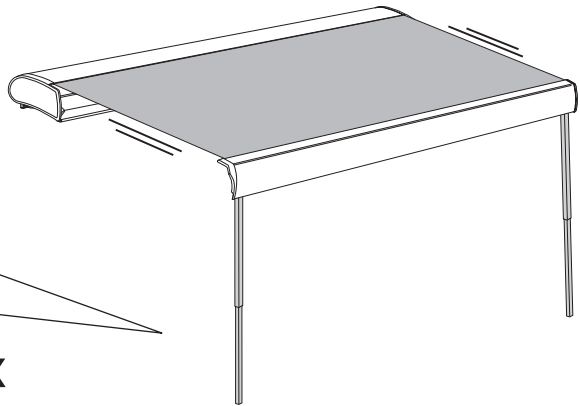

2**ONLY IN CASE OF OPTIONAL TENSION-ARM SET****Tension Arm Set TO 6300
302095**

3.03 m

3.28 m

3.53 m

3.78 m

4.03 m

4.28 m

4.53 m

5.03 m

OPTION

OPTION

OPTION

✓

✓

✓

✓

✓

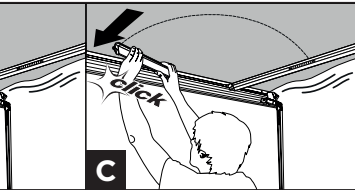
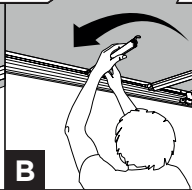
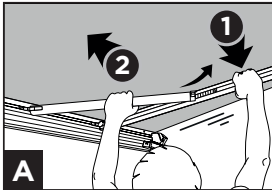
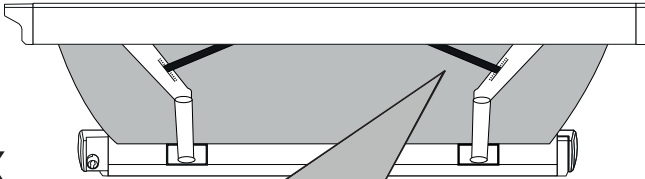
2 x

3

A

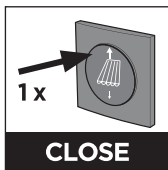

B

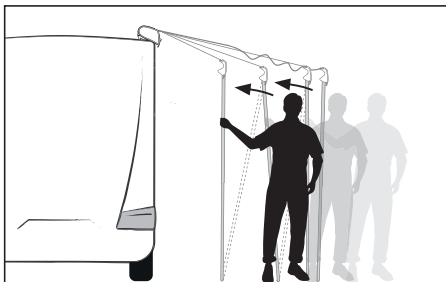

C

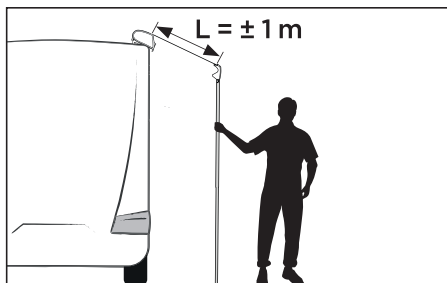

D

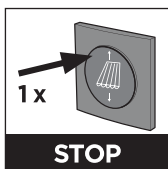

AUTOMATIC



4

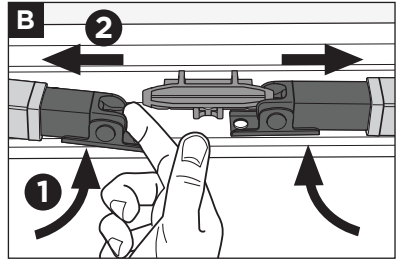
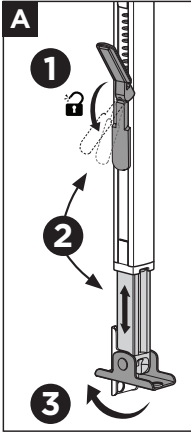
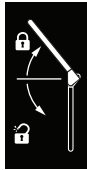
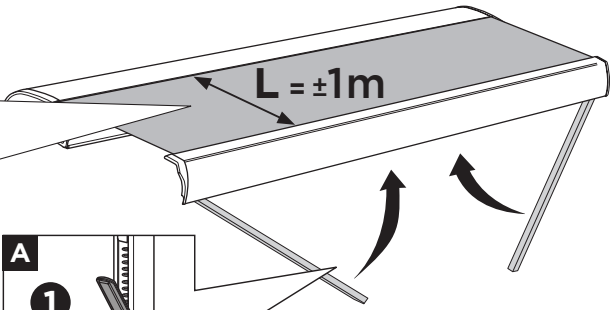
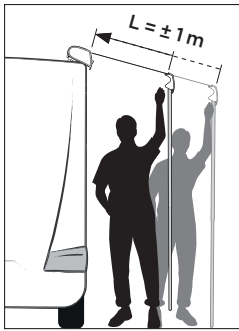

5

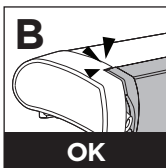
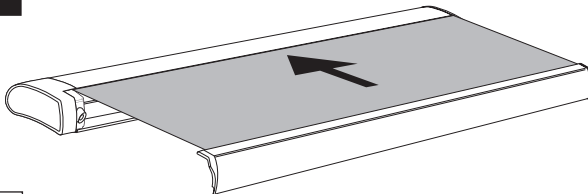
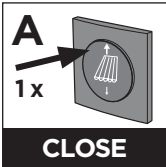



1

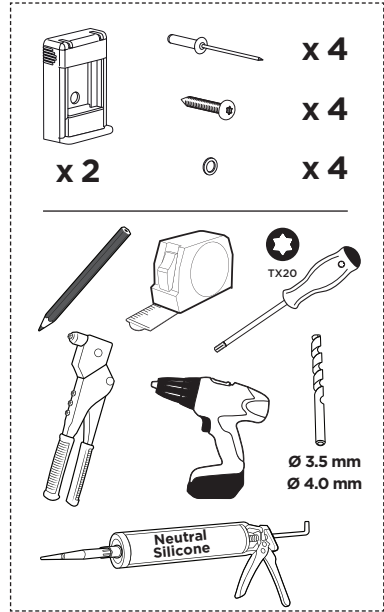
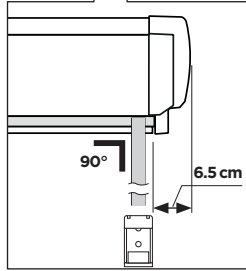
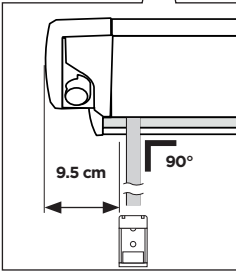
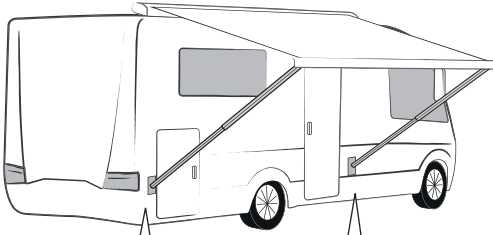

2

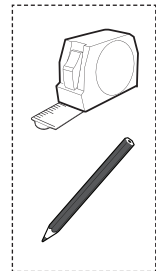
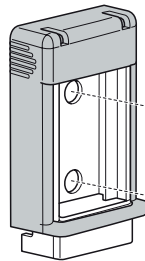
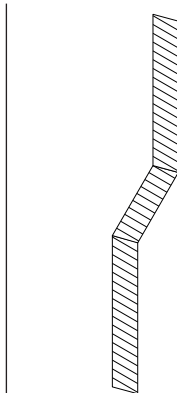
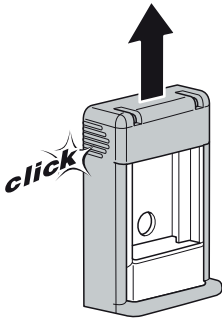

3

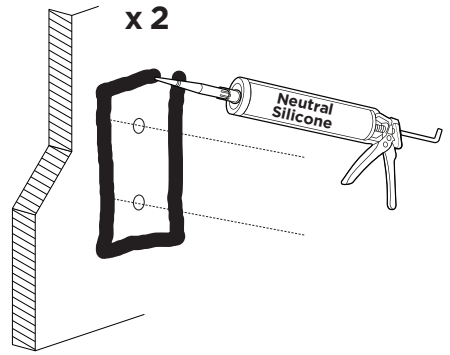
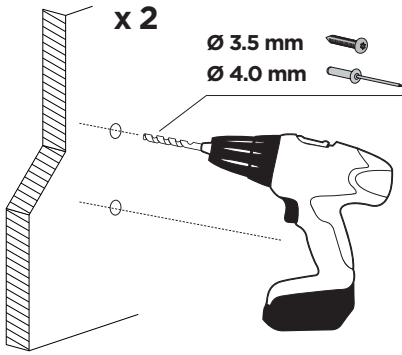

4

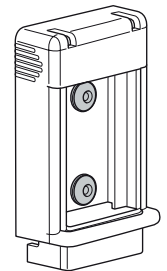
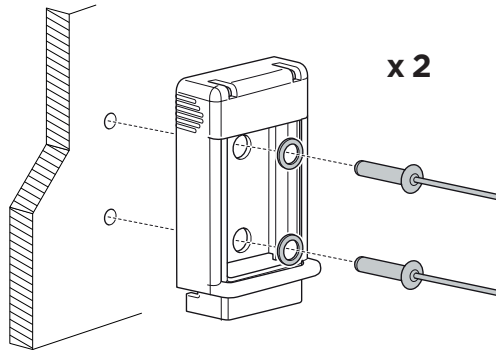
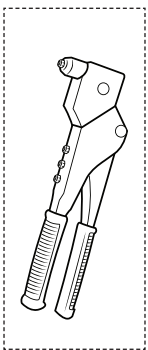
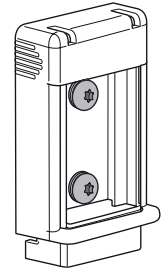
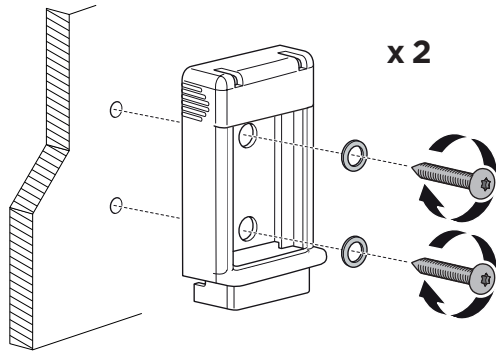
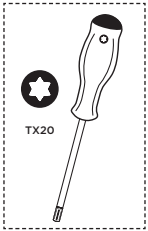

5

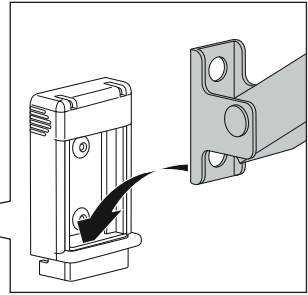
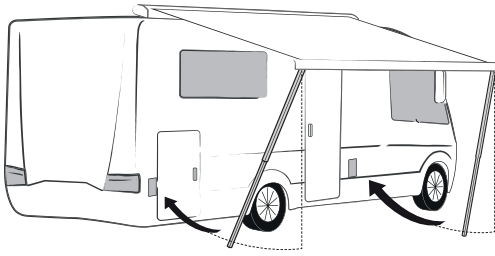

A

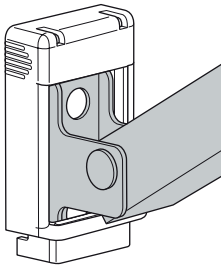

B

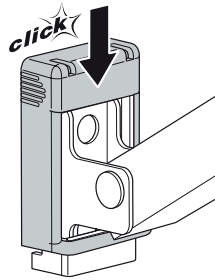

C

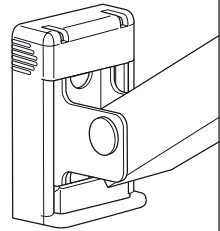

MANUAL OVERRIDE

1

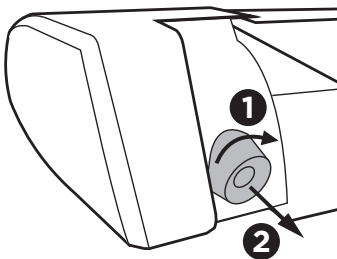

2

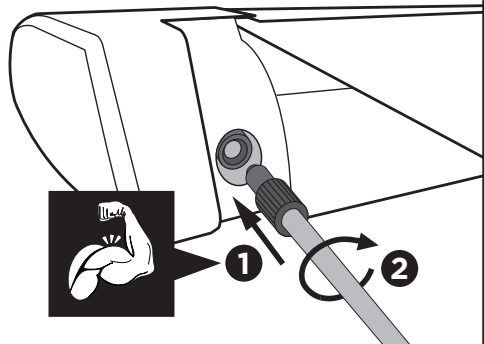



PITCH CONTROL

i

3C
3B
3A

✓

⚠

✗

DOOR

5 mm

x 2

x 8

1

L R

x 2

2

90°

3

L = R

A 1x 4x

B 1x 3x

C 1x 2x

!

✗

1x 0x

✗

1x 1x

NOT OK

NOT OK

4

L R

x 2

AWNING ACCESSOIRES

Thule Hold Down Side Strap Kit

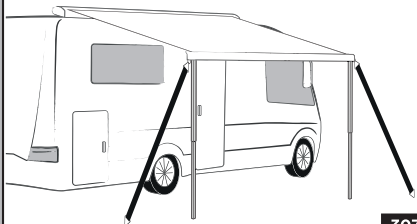

307916

Thule 3rd Support Leg



306778

Thule Tent LED Mounting Rail TO 6300



301664

301660

307124

Thule Tension Arm Set TO 6300

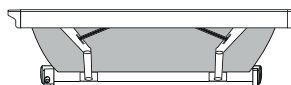

302095

Thule LED Mounting Rail



306777

307134

Thule EPDM Sealing

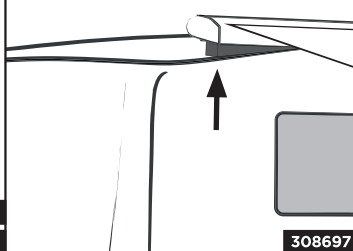

308697

Thule Smart Panels

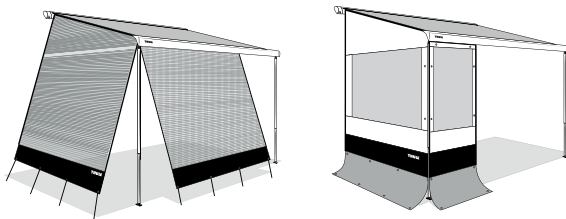

Thule PVC Cleaner



307585

THULE TENTS

Thule Panorama

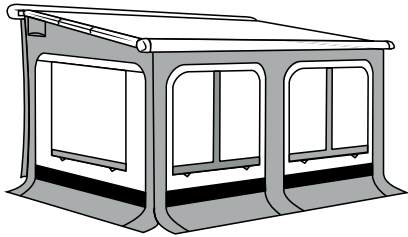

Thule Residence G3

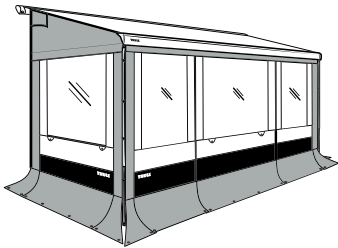

Thule QuickFit

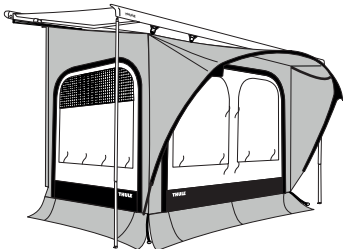

GENERAL MARKS:

- Installation must be carried out by a qualified person.
- Check if you have a solid back ground for installation of the adapters of the awning. Fixation must be carried out by bolts and nuts and counterplate and by preference also glued with SIKA 252. Contact your dealer or manufacturer of the vehicle. Before drilling, be sure that there is no obstacle at the inside (for example electric cables, gas pipes and so on).
- The adapters must support the awning at the awnings spring arms for a correct and stable mounting. When this is not possible use a full length adapter.
- In order to get a watertight installation, use acid free silicone or SIKA 252 to fill up the drilled holes.
- For the mounting height of the bottom mounting brackets ask your dealer or manufacturer.
- An awning is a sun and not an all-weather protection. The awning should be closed in case of storm, snow or heavy rain fall (avoid formation of a water pocket).

THULE WARRANTY:

1. The warranty for the THULE awning to the original buyer is two years from date of invoice.
2. The warranty covers replacement of parts arising from defects and from the inability of the awning to perform its intended function.
3. In case of a defect, consult your dealer with original invoice.
4. Defects, which in our judgment occur from misuse, negligence or accident, are not covered by the warranty. In addition, the warranty does not apply if the product is installed or handled improperly or if the awning has been altered in any way or has been repaired by unqualified persons, or if the serial number and/or date has been altered or removed.

5. In case of use of non-original Thule accessories, the warranty will be declared invalid.
6. Should the original buyer wish to return to us parts believed to be defective, the parts should be sent prepaid. If we find the parts defective and covered by warranty, they will be repaired and returned. If warranty does not apply or has expired, a nominal charge will be made. Any transport costs are for the owner's account.
7. Returned goods should be in solid wrapping.
8. No other warranty is given and no representative is authorised to give any warranty or assume liability by words or action under any warranty other than that is contained herein. This warranty is expressly in lieu of any other expressed or implied warranty of whatever nature and expressly excludes any other or further liability.

NL Algemene opmerkingen en Thule garantie

ALGEMENE OPMERKINGEN:

- De montage moet gebeuren door gekwalificeerd personeel.
- Controleer of het dak van het voertuig stevig genoeg is om de adapters van de luifel aan te brengen. De bevestiging moet met bout-moer verbinding en tegenplaat gebeuren en bij voorkeur extra vastgekleefd met SIKA 252. (Raadpleeg uw verdeler of de fabrikant van het voertuig). Controleer ook of er geen hindernissen zijn aan de binnenkant van het voertuig (vb elektrische kabels, gasleiding, enz.).
- Voor een correcte en stabiele plaatsing moeten de adapters geplaatst worden ter hoogte van de knikarmen. Indien dit niet mogelijk is gebruik een adapter op volle lengte.
- Voor een waterdichte montage, vul de geboorde gaten op met zuurvrije silicone-pasta of SIKA 221.
- Voor de montagehoogte van de beugeltjes voor de steunvoeten, raadpleeg uw handelaar of constructeur.

- Een luifel biedt bescherming tegen de zon, niet tegen andere weersinvloeden. Bij storm, sneeuw of hevige regen dient de luifel dichtgedraaid te worden (vermijd vorming van een waterzak).

THULE GARANTIE:

1. De THULE luifel heeft voor de koper 2 jaar garantie vanaf de datum van factuur.
2. De garantie geldt voor vervanging van onderdelen die defect of onvolledig zijn en voor het niet naar behoren functioneren van de luifel.
3. In geval van defecten kunt u zich richten tot uw dealer met bewijs van factuur.
4. Defecten die ontstaan door onoordeelkundig gebruik, nalatigheid of ongeval, vallen niet onder de garantie. Bovendien vervalt de garantie als het produkt niet naar behoren is gemonteerd. Ook geldt geen garantie als veranderingen zijn aangebracht of als de luifel door ondeskundige personen is gerepareerd. De garantie vervalt ook als het serienummer en/of datum gewijzigd of veranderd is.
5. Indien men gebruik maakt van niet-originele THULE-accessoires vervalt de garantie.
6. Als de koper bepaalde onderdelen die hij als defect beschouwt, wenst terug te sturen, zijn de transportkosten voor de verzender. Als deze onderdelen door ons als defect worden beschouwd en onder garantie vallen, zullen deze hersteld en teruggestuurd worden. Indien de garantie niet van toepassing is, worden herstellingskosten in rekening gebracht. Transportkosten zijn voor rekening van de klant.
7. Produkten of onderdelen die teruggestuurd worden, moeten goed verpakt zijn.
8. Een andere vorm van garantie dan hier beschreven, wordt niet verleend. Vertegenwoordigers zijn niet gemachtigd om garanties af te geven, zowel schriftelijk als mondeling, voor andere zaken dan in deze garantiebepalingen is vastgesteld. Met deze garantiebepalingen vervallen alle eerder bepaalde en verstrekte garanties van welke aard ook. Verdere aanspraken zijn uitgesloten.

ALGEMEINE BEMERKUNGEN:

- Die Montage muss von fachkundigem Personal ausgeführt werden.
- Achten Sie darauf, dass für die stabile Montage der Adapter geeignete Befestigungspunkte vorhanden sein müssen. Die Adapter werden zunächst mit SIKA 252 auf dem Fahrzeugdach geklebt und dann mit einer Schrauben-Mutter-Verbindung und Gegenplatte fixiert. Achten Sie darauf, dass Sie beim Bohren keine wichtigen Bauteile, wie insbesondere Gas- und Stromleitungen, im Inneren des Fahrzeugs beschädigen.
- Für eine korrekte und stabile Montage, müssen die Adapter an den Spannfedernarmen die Markise unterstützen. Wenn dies nicht möglich sein sollte, benutzen Sie einen Längenadapter.
- Füllen Sie die Bohrlöcher mit säurefreiem Silikon oder SIKA 221, um eine wasserdichte Montage zu bekommen.
- Über die Möglichkeit der Montage der Wandhalter für die Stützbeine befragen Sie bitte Ihren Händler oder Hersteller des Fahrzeugs.
- Eine Markise ist ein Sonnenschutz und kein All-Wetter-Schutz. Die Markise muss bei kräftigem/stürmischem Wind, Schneefall oder starkem Regen eingefahren werden (u.a. um Regenwasserbeulen zu vermeiden).

THULE GARANTIE:

1. Für die THULE Markise wird ab Datum des Kaufbeleges eine zweijährige Garantie gewährt.
2. Innerhalb der Garantiezeit beseitigen wir alle Funktionsfehler an der Markise, die nachweisbar auf mangelhafte Ausführung oder Materialfehler zurückzuführen sind.
3. Im Falle eines Mangels wenden Sie sich bitte unter Vorlage des Kaufbeleges an Ihren Fachhändler.
4. Funktionsfehler, die nachweislich durch falschen Gebrauch, Nachlässigkeit oder einen Unfall entstanden sind, werden von der Garantie ausgeschlossen. Die Garantie erlischt auch, wenn die Markise

unsachgemäss montiert, gehandhabt, die Seriennummer verändert, entfernt oder wenn an der Markise in irgendeiner Weise modifiziert wurde.

5. Bei Verwendung von nicht originale Thule-Zubehör wird die Garantie für ungültig erklärt.
6. Falls Sie uns ein oder mehrere Ersatzteile zusenden wollen, die Sie für fehlerhaft halten, bitten wir, uns diese fracht- und portofrei zuzusenden. Sollten sich diese Teile als mangelhaft herausstellen, werden diese von uns repariert und zurückgesandt. Ist es kein Funktions- oder Materialfehler, oder ist die Garantiezeit abgelaufen, werden die Reparaturkosten berechnet. Alle Fracht und Transportkosten gehen in diesem Falle zu Lasten des Kunden. Durch die Instandsetzung wird die Garantiezeit nicht erneuert oder verlängert.
7. Ersatzteile sind vor der Rücksendung zu verpacken.
8. Es wird keine andere Garantie abgegeben. Weder ein Vertreter unseres Hauses oder ein Fachhändler ist berechtigt, mündlich oder schriftlich irgendeine andere, als die hier erklärte Garantie abzugeben oder eine Haftung zu übernehmen. Diese Garantie tritt an die Stelle jeglicher andere Garantien gleich welcher Art, und schliesst ausdrücklich jegliche Haftung aus.

FR Remarques generales et la garantie Thule

REMARQUES GENERALES:

- Le montage doit être effectué par des techniciens.
- Sondez le toit du véhicule pour définir l'endroit de fixation des pièces d'adaptations du store. Le montage se fait à l'aide de boulons, écrous et contre-plaques; l'emploi de mastic SIKA 252 est conseillé. (Consultez votre agent ou le constructeur du véhicule). Avant de percer, assurez-vous qu'il n'y a pas d'obstacles à l'intérieur du véhicule (par exemple des câbles électriques, des tubes de gaz, etc.).

- Pour un montage correct et stable déterminez la position des adaptateurs en les positionnant derrière les supports de bras. Si c'est non-possible utilisez un adaptateur sur longueur.
- Afin d'obtenir un montage étanche à l'eau, utilisez une pâte de silicone sans acide ou SIKA 221 pour remplir les trous percés.
- Un store est une protection solaire et pas une protection contre les intempéries. En cas de précipitation pluvieuses ou de rafales de vent, le store doit être fermé (evitez la formation d'une poche d'eau).

LA GARANTIE THULE:

1. Le store THULE est garanti pendant 2 ans, à dater du jour de la facture, pourvu qu'il reste en possession de l'acheteur initial.
2. La garantie couvre tous les vices de fabrication et de matière. Elle s'étend aux frais de pièces s'y rapportant.
3. Pour toutes les pièces défectueuses, nous vous demandons de bien vouloir consulter votre concessionnaire sans omettre de lui fournir une copie de la facture d'achat.
4. La garantie ne peut être invoquée dans le cas d'un acte de négligence, d'un accident, ou de l'intervention sur le produit par des personnes non qualifiées, si le store n'a pas été monté ou utilisé suivant nos instructions ou si le numéro de série a été altéré ou effacé.
5. La garantie n'est plus d'application en cas d'utilisation d'accessoires non originaux Thule
6. Tout acheteur d'un produit neuf désirant nous renvoyer des pièces défectueuses s'engage à payer les frais de transport. Dès le retour, l'article sera examiné par THULE afin de constater s'il satisfait aux conditions de garantie. Dans l'affirmative, il vous sera retourné après réparation. Si la garantie n'est pas applicable, les frais de réparation et de transport seront à la charge du propriétaire.
7. Les produits retournés à l'usine devront être emballés convenablement.
8. Aucune autre garantie n'est accordée. Aucune personne ou représentant n'est habilité à accorder des garanties en d'autres termes que ceux indiqués ci-dessus.

NOTE GENERALI:

- L'installazione deve essere eseguita da una persona qualificata.
- Controllare la solidità della parete prima di fissare gli adattatori. Montare con bulloni e dadi e anche con una contropiastra. (Consultare il fabbricante del veicolo). Assicurarsi che non ci siano ostacoli all'interno (per esempio cavi elettrici, condotti del gas, ecc.) prima di forare.
- Per un corretto e stabile montaggio, gli adattatori devono supportare la tenda alle braccia della molla della tenda. Quando ciò non è possibile utilizzare un adattatore più lungo.
- Per ottenere un'installazione impermeabile, riempire i fori di un silicone senza acido o SIKA 221.
- La tenda è una protezione dal sole e non per la pioggia. La tenda va chiusa in caso di temporale, neve o pesante pioggia (evitare la formazione di sacche di pioggia).

LA GARANZIA THULE:

1. La tenda della THULE è garantita per 2 anni a partire della data della fattura.
2. La garanzia vale per la sostituzione di tutte le parti difettose o incomplete e per la riparazione della tenda se non funziona correttamente.
3. In caso di difetti, le preghiamo di andare dal Suo concessionario con la Sua fattura.
4. La garanzia non può essere invocata in caso di negligenza, di un incidente o di un'intervenzione di una persona non qualificata. Inoltre, la garanzia non è applicabile se la tenda non è stata installata o utilizzata secondo le nostre istruzioni.
5. In caso di utilizzo di accessori non THULE, la garanzia sarà considerata nulla

6. Se il compratore rimanda parti difettose alla THULE , deve pagare le spese di trasporto. Se queste parti sono davvero difettose e se la garanzia è applicabile, saranno riparate e rinviate. Se la garanzia non è applicabile, le spese della riparazione e del trasporto dovranno essere pagate dal proprietario.
7. Tutti i prodotti e tutte le parti rinviati alla ditta devono essere ben imballati.
8. Nessun altra garanzia viene accordata. Nessun rappresentante ha l'autorizzazione di accordare altre garanzie, sia in modo scritto che in modo orale, oltre delle garanzie descritte qui. Questa garanzia sostituisce qualsiasi garanzia precedente e esclude ogni altra responsabilità.

SE Generella anmärkningar och garantin Thule

GENERELLA ANMÄRKNINGAR:

- Installationen måste genomföras av en kvalificerad person.
- Kontrollera att du har en stabil yta att installera markisens adapter på. Fixeringen måste ske med genomgående bultar och med invändig monteringsplatta. Täta genomföringarna med anpassat tätningsmedel tex. SIKA 252 för att undvika läckage. Kontakta din återförsäljare eller fordonstillverkaren innan du borrar för vara att säker på att du inte skadar några föremål på insidan (t.ex. kablar, gasledningar med mera).
- Adaptrarna måste stödja tältet vid stödmarna, för en korrekt och stabil montering. När detta inte är möjligt, använd en full längd adapter.
- För en vattentät installation, använd lämpligt tätningsmedel tex. SIKA 221 för att täta genom-föringarna.
- För monteringshöjd av väggbeslagen till stödbenen, fråga din återförsäljare eller tillverkare.
- Awning 6903 är ett solskydd, ej allvädersskydd. Den ska vara stängd vid risk för storm, snö eller kraftigt regn (undvik vattenansamlingar på duken).

THULES GARANTI:

1. Garantien för THULE s markis är på två år från inköpsdatum och gäller för personen som stod för inköpet.
2. Garantien täcker ersättning av delar som är trasiga eller som inte fungerar.
3. Om ett fel upptäcks på produkten, kontakta din återförsäljare och ta med dig ditt kvitto.
4. Skador som enligt vår bedömning har uppkommit på grund av felanvändning, slarv eller genom en olycka täcks inte av garantien. Dessutom gäller inte garantien om produkten är monterad eller omskött på fel sätt. Garantien gäller inte heller om markisen har blivit lagad av okvalificerad personal eller om något har ändrats på markisen. Om serienummer/datum har ändrats eller blivit borttaget så gäller inte garantien.
5. Vid användande av icke Thule originaltillbehör gäller ej garantien
6. Skulle köparen önska att skicka tillbaka delar som han anser vara trasiga skall fraktkostnaderna vara förutbetalda. Om delarna är trasiga och täcks av garantien, reparerar vi delarna och återsänder dem. Om garantien inte gäller eller har gått ut så kommer en symbolisk avgift att debiteras. Alla transportkostnader står kunden för.
7. Returnerade varor skall vara ordentligt emballerade.
8. Ingen annan garanti ges och ingen annan representant är auktoriserad att ge någon garanti eller anlägga någon ansvarsskyldighet muntligt eller skriftligt förutom den garantien som finns här. Den här garantien står över någon annan uttryckt eller underförstådd garanti och vi avsäger oss allt övrigt ansvar.

YLEISIÄ HUOMIOITA:

- Tuotteen saa asentaa vain koulutettu asentaja.
- Varmista, että markiisin asennusadapteri asennetaan tukevaan taustaan. Kiinnitys on tehtävä pulteilla, muttereilla ja vastalevyillä, sekä tiivistettävä SIKA 252 liimalla. Ota yhteys jälleenmyyjäsi tai ajoneuvon valmistajaan. Ennen poraamista varmista, ettei reiän takana ole mitään (esimerkiksi sähköjohtoja, kaasuputkia jne).
- Asianmukaisen ja vakaan kokoonpano vaati , että sovittimet täytyy tukia teltoa tukivarsista. Jos tämä ei ole mahdollista , käyttää täyspitkää sovitinta.
- Saadaksesi vesitiiviin asennuksen käytä hapotonta silikonia tai SIKA 221 liimaa reikien tiivistämiseen.
- Kysy jälleenmyyjältä oikea asennuskorkeus tukijalkojen seinäkiinnikkeille.
- Markiisi on aurinko eikä jokasään suoja. Markiisi tulisi olla suljettu , kun on myrsky-, lumi - tai rankkasaden vaara (vältä lätäköitä kankaalle).

THULE TAKUU:

1. THULE markiisin takuu on ensikäyttäjälle kaksi vuotta alkuperäisestä ostopäivästä.
2. Takuu kattaa viallisten tai väärin toimivien osien vaihdon.
3. Takuutapauksissa ota yhteys jälleenmyyjään ostotositteen kanssa.
4. Vauriot, jotka johtuvat väärinkäytöstä, huolimattomuudesta tai onnettomuuksista eivät kuulu takuun piiriin. Takuu ei myöskään ole voimassa, jos tuote on asennettu virheellisesti, sitä on käytetty väärin, siihen on tehty muutoksia, sitä on korjattu virheellisesti tai sen tunnistetiedot on poistettu tai muutettu.
5. Käytettäessä lisävarusteita, jotka eivät ole alkuperäisiä Thule-tuotteita, takuu ei ole voimassa.

6. Jos alkuperäinen ostaja haluaa lähettää vaurioituneita osia tarkistettavaksi, on ne lähetettävä rahtikulut maksettuina. Jos osat todetaan vaurioituneiksi ja takuunalaisiksi, ne korjataan tai vaihdetaan sekä palautetaan. Jos takuu ei kata osaa tai takuu-aika on päättynyt, veloitetaan osista normaalisti. Rahtikulut peritään omistajalta.
7. Palautettavat osat on pakattava huolellisesti.
8. Muuta takuuta ei anneta. Edustajilla ei ole oikeutta muutoksiin tai vastuunottoon suullisesti tai muulla tavoin tässä mainitusta poiketen. Tämä takuu korvaa kaikki aiemmin voimassa olleet takuut ja täten irtisanoudumme kaikesta muuta vastuusta.

